



## Alluma LED Desk Lamp

Model No.: A41-C

### Questions or Concerns?

(855) 686-3835

[support@etekcity.com](mailto:support@etekcity.com)

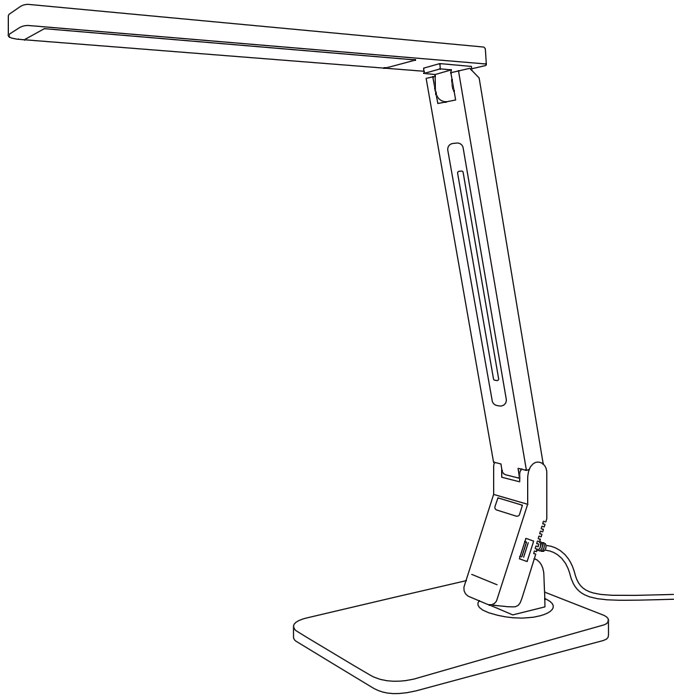

Thank you for purchasing the Alluma LED Desk Lamp (A41-C) by Etekcitec. This high power, eco-friendly lamp enables users to adjust lighting brightness and color temperature according to the appropriate application. Whether used to read, study, or relax, this lamp is automatically set to the best lighting conditions for each use without the hassle of eye strain or exhaustion while charging nearly any device with the included USB charging port, enhancing the efficiency in your work or study space.

We're constantly working at building better living with the products and services we create. Should you ever experience any issues with your new product, feel free to contact our helpful customer service team toll-free at (855) 686-3835 or by e-mail at [support@etekcity.com](mailto:support@etekcity.com).



## Safety Information

**IMPORTANT:** Please read and comply with all of the instructions and warnings provided in this manual before using the product. Failure to comply with the instructions and warnings provided herein may result in inaccurate results and/or damage to the product itself.

- **DO NOT** attempt to repair, disassemble or modify under any circumstances.
- **DO NOT** look directly into the LED light.
- **DO NOT** place near any heat source or in direct sunlight.
- Place on a flat, secure surface.
- Only use the supplied AC power adapter to operate the lamp.
- **DO NOT** use the lamp if the electrical power cord is frayed or damaged.
- **DO NOT** touch any electrical appliances with wet hands or near liquid.
- Keep the light and power cord dry and clean at all times.
- **DO NOT** operate this lamp in damp or moist environments.
- In order to avoid an overload, do not plug a USB charging port extender to the lamp. Only charge one

- device at a time when using the desk lamp.
- Unplug the adapter when the light is not in use for an extended period of time.
- **DO NOT** attempt to repair or disassemble the device. Doing so may void any warranty.
- Never overload electrical circuits as it may cause an electrical shock or hazardous fire.
- In order to maintain normal operation, use only the included power cable with the desk lamp.









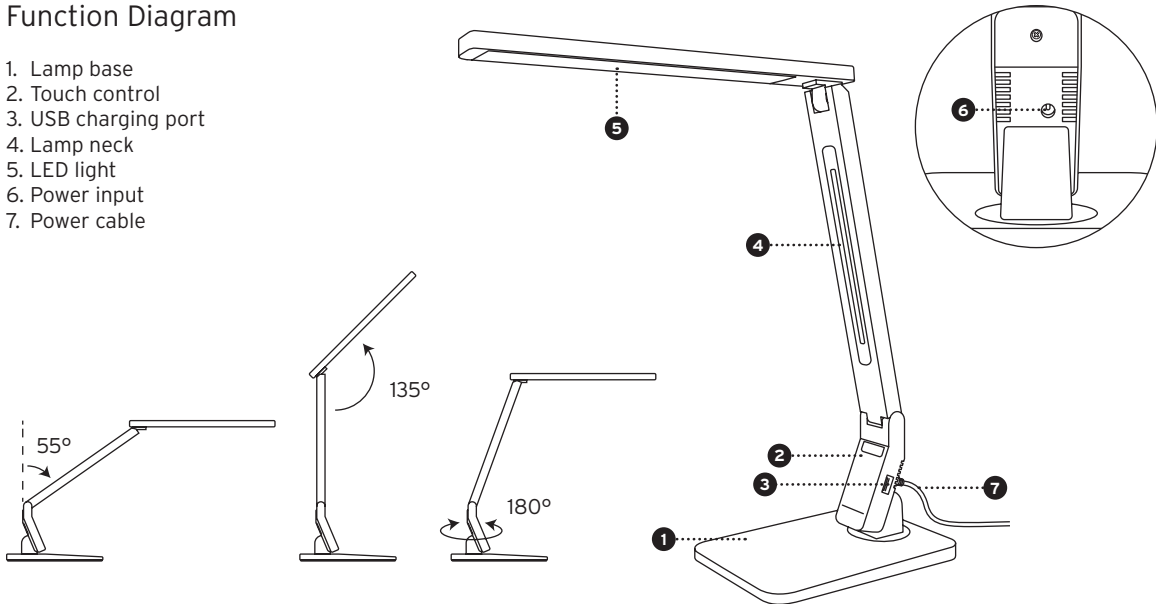

# Main Functions

## Function Diagram

1. Lamp base
2. Touch control
3. USB charging port
4. Lamp neck
5. LED light
6. Power input
7. Power cable



## Button Functions

Button	Symbol	Color Temperature	Function
Power			Turn the lamp power on and off.
Read Mode		4500k - 5200k	Stimulates concentration and reduces eye strain with mid-range color temperature.
Study Mode		5400k - 6100k	Increases attention and concentration with high-range color temperature.
Relax Mode		3400k - 4100k	Increases relaxation and improves mood with low-range color temperature.
Sleep Mode		2700k - 3400k	Stimulates a deep sleep with the comfort of soft light.
Timer			Automatically shuts off light after 1 hour of operation in any brightness mode.
Increase Brightness			Increase light brightness.
Decrease Brightness			Decrease light brightness.



## Set-Up

Plug the included power cable into the lamp's DC power input, then plug the adapter into a powered outlet.

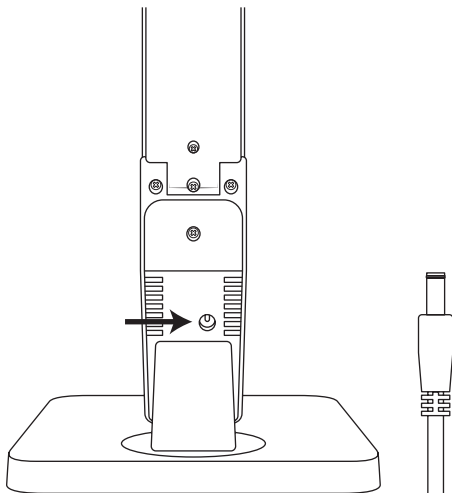

## Operation

1. Press the '⏻' button to turn on the lamp.
2. To change the color mode, press the desired mode according to its symbol.
3. Press the '+' button repeatedly to increase the lamp's brightness. There are up to 5 available levels of brightness.
4. Press the '-' button repeatedly to decrease the lamp's brightness. There are up to 5 available levels of brightness.

**NOTE:** Each mode's default brightness level is Level 3. The lamp will remember the last mode and brightness level when turned on and off; however, this memory function will not work if the power source is interrupted.

5. Press the '⏻' button to set a 60 minute auto-off timer for the lamp's light.

**NOTE:** The '⏻' button will begin flashing to indicate that the timer has been set.

## Charging Devices

To charge a device, plug the device to a USB cable and plug the cable into the desk lamp's USB charging port. The device will begin to automatically charge.

**NOTE:** To charge a device, you must have a compatible USB charging cable. The USB output is DC 5V./1.5A. If the charging current is greater than 1.5A (i.e. iPad, tablets, etc.), then the charging speed will be affected. The lamp's light does not need to remain on in order to charge a device.

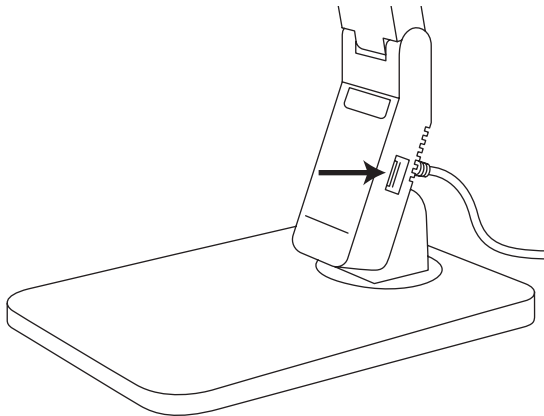

## Cleaning & Maintenance

### Cleaning

Unplug any connected device and disconnect the lamp. Use a slightly damp soft cloth to clean the surface of the lamp. Wipe dry with a soft cloth.

### Disassembly

For easy storage, unscrew the plastic cap located on the bottom of the desk lamp, rotating counter clockwise. Remove the cap to detach the lamp neck from the lamp base.



## Specifications

Modes:	Reading / Study / Relax / Sleep
Brightness Levels:	5
LED Power:	6 - 11W
Max Lumen:	530 LM
Max Illumination (30cm away from light source):	> 2000 lux
Color Temperature:	2700 - 6100K
Power Input:	AC 100-240V 50/60Hz
USB Output:	DC 5V / 1.5A
DC Input:	12V

## Package Contents

- 1 x Alluma LED Desk Lamp
- 1 x User Manual
- 1 x Adapter



## Customer Support

Should you encounter any issues or have any questions regarding your new product, feel free to contact our helpful Customer Support Team. Your satisfaction is ours!

### **Etekcify Corporation**

1202 N Miller Street, Suite A  
Anaheim, CA 92806

Toll-Free:	(855) 686-3835
Fax:	(657) 202-1693
Local:	(657) 500-1872
Email:	support@etekcity.com
Live Chat:	www.etekcity.com

### **Support Hours**

Monday - Friday: 9:00am - 5:00pm PST

*\*Please have your order number ready before contacting customer support.*





# Warranty Information

## Terms & Policy

Etekcity warrants all products to be of the highest quality in material, craftsmanship and service for a minimum of 1 year, effective from the date of purchase. Warranty lengths may vary between product categories. For specific warranty terms, please refer to your product listing page or product operation manual.

Under the limited warranty, Etekcity will replace or refund any product found to be defective due to manufacturer flaws based on eligibility. This warranty extends only to personal use and does not extend to any product that has been used for commercial use, rental use, or any other use in which the product is not intended for. There are no warranties other than that expressly set forth with each product.

This warranty is non-transferrable. Etekcity is not responsible in any way for any damages, losses or inconveniences caused by equipment failure or by user negligence, abuse, or use noncompliant with the user manual or any additional safety, use, or warnings included in the product packaging and manual.

Etekcity and its subsidiaries assume no liability for damage caused by the use of the product other than for its intended use or as instructed above and within the user manual. Some states do not allow this exclusion or limitation of incidental or consequential losses so the foregoing disclaimer may not apply to you. This warranty gives you specific legal rights and you may also have other rights which may vary from state to state.

ALL EXPRESS AND IMPLIED WARRANTIES, INCLUDING THE WARRANTY OF MERCHANTABILITY, ARE LIMITED TO THE PERIOD OF THE LIMITED WARRANTY.

Should your product prove defective within the specified warranty period, please return the defective unit in its original packaging with (1) an original copy of invoice, (2) your warranty ID number, (3) and your order number.

## Exceptions & Exclusions

- Damage due to abuse, accident, alteration, misuse, tampering or vandalism.
- Improper or inadequate maintenance.
- Damage in return transit.
- Unsupervised use by children under 18 years of age.

To receive a valid warranty ID number, sign into your Etekcitec customer account at [www.etekcity.com](http://www.etekcity.com). At the top of the warranty page, type in your order number located in your order invoice to retrieve your warranty ID number. Your warranty ID number will then be sent to your email for your records. If deemed defective, your product will be replaced or refunded at no charge to you, based on eligibility.

Date of Purchase: \_\_\_\_\_

Place of Purchase: \_\_\_\_\_

Order ID: \_\_\_\_\_

Warranty ID: \_\_\_\_\_

To register your warranty or to make a claim, please contact our helpful customer support team at (855) 686-3835 or email **[support@etekcity.com](mailto:support@etekcity.com)**.

*\*Please have your order ID number ready before contacting customer support.*





Scan here and join the community!  
<http://www.etekcity.com>