

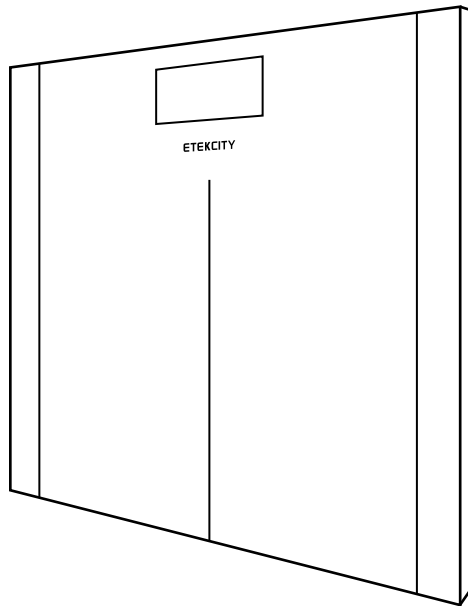

## Digital Body Weight Scale

Model No.: EB9380H



## **Thank You.**

Thank you for purchasing the EB9380H Digital Body Weight Scale by Etekcity. We are dedicated to providing our customers with quality products for building a better living. Should you have any questions or concerns about using your new product, feel free to reach out to our helpful customer support team at (855) 686-3835 or by email at [support@etekcity.com](mailto:support@etekcity.com). We hope you enjoy your new product!

## Package Contents

- 1 x Digital Body Weight Scale
- 1 x User Manual
- 1 x Measuring Tape
- 2 x 1.5V AAA batteries (pre-installed)

## Table of Contents

Safety Information	4
Main Functions	5
Set-Up	6
Operation	7
Maintenance	8
Specifications	10
Troubleshooting	11
Warranty	12
Customer Support	13

# Safety Information

**IMPORTANT:** Please read and comply with all of the instructions and warnings provided in this manual before using the product. Failure to comply with the instructions and warnings provided herein may result in inaccurate results and/or damage to the product itself.

- The glass platform is slippery when wet. Make sure the platform is dry before stepping on for measurement.
- Consult your primary-care doctor or physician before making changes to your diet, exercise plans, and/or physical activities.
- This scale is not intended for commercial use.
- To weigh safely and accurately, please stand on the center of the platform and stand still until a result is calculated.
- **DO NOT** strike or drop the scale.
- **DO NOT** stand on the edge of the scale or jump on it.
- **DO NOT** stand on the scale platform for a prolonged period of time or when not in weighing operation.
- Always place the scale on a hard, dry, and flat surface before measurement.
- Handle the scale with care, as it is a precision instrument.
- Clean the scale with a damp cloth and avoid getting water or any other liquid inside the scale.
- **DO NOT** use chemical or abrasive cleaning agents to clean the scale.
- Keep the scale in a cool environment with dry air.
- Always keep the scale in a horizontal position; do not store vertically.
- If the scale fails to turn on, check whether the batteries are installed correctly. Replace the batteries if necessary.
- If an error appears on the display or if the scale does not turn off automatically, remove the batteries for 3 seconds, then reinstall them.
- **DO NOT** overload the scale (max. weight capacity: 400 lb / 180 kg).
- If the scale is not in use for an extended period of time, remove the batteries to ensure battery conservation and to extend the scale service lifetime.

# Main Functions

1. Scale platform
2. Digital display
3. Unit selection

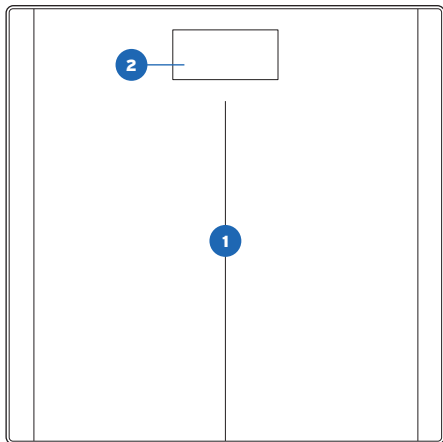

4. Battery compartment
5. Anti-skid padding

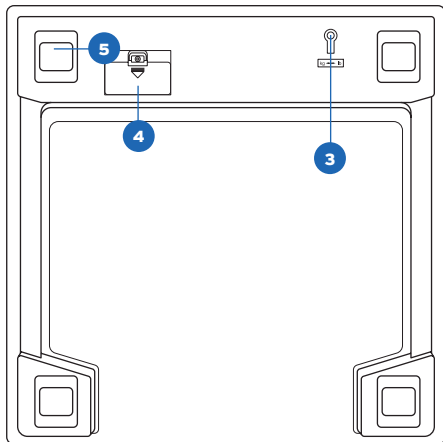

## Set-Up

Open the battery compartment cover located on the back of the scale. Remove the two 1.5V AAA batteries from their plastic film and apply the batteries under the correct polarity. Reseal the battery compartment in order to activate the scale.

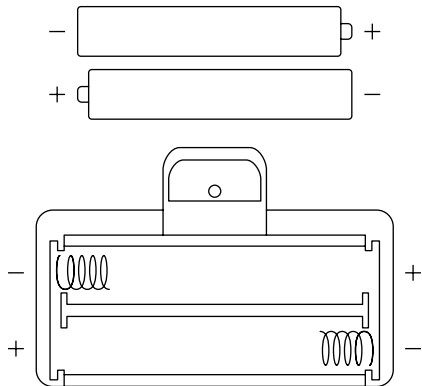
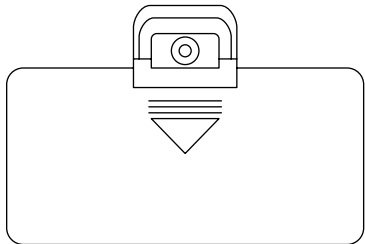

# Operation

## Weight Measurement

1. For best results, place the scale on a hard, flat surfaces. Avoid carpet or soft surfaces.
2. Gently step on the scale. The scale will automatically activate.
3. Remain standing evenly on the scale, without moving or shifting your feet or body. The scale will then display and flash your final results.

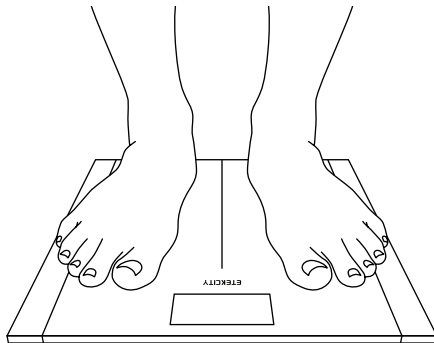
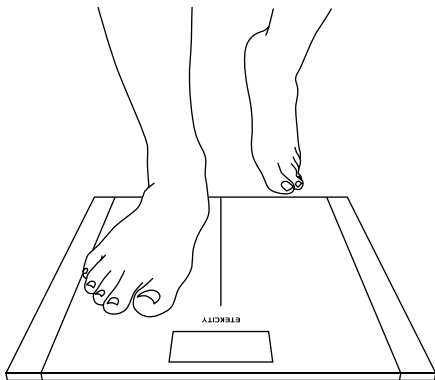

## Converting Weight Units

1. Apply pressure onto the weighing platform to activate the scale.
2. Press the unit conversion button on the back of the scale to convert units from pounds (lb) to kilograms (kg).
3. Place the scale back onto a hard, flat surface when you are ready to measure.

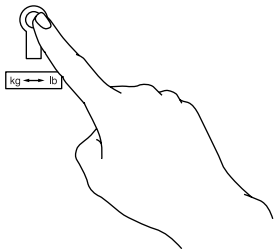

**NOTE:** For accuracy, the digital scale may trigger automatic calibration when physically lifted and moved or when the unit of measurement is changed. Should a 'C' appear on the digital display at any time, recalibrate the scale as noted in the Recalibrating the Scale section.

## Maintenance

### Battery Replacement

1. Open the battery compartment on the back of the scale.
2. Remove the old batteries and dispose of them properly.
3. Install two new 1.5V AAA batteries, making sure they are placed under the correct polarity.
4. Replace the battery compartment cover.

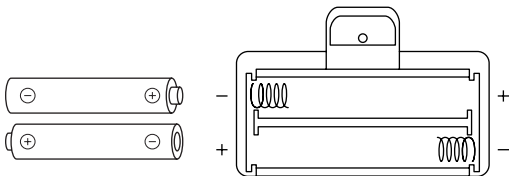

**NOTE:** The scale may need to be recalibrated after replacing the batteries.



## Recalibrating the Scale

If the scale has been moved or flipped upside down, it must be recalibrated to ensure accurate results.

1. Place the scale on a hard, flat surface.
2. Step on the scale with one foot until the display lights up, then step off.
3. The scale will show "0.0," indicating that the calibration was successful.

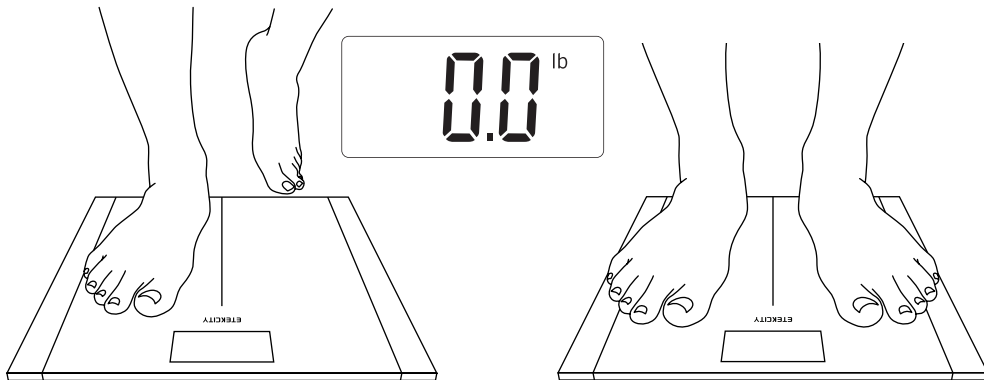

## Specifications

Weight Capacity:	400 lb (180 kg)
Graduation:	0.2 lb (0.1 kg)
Weight Units:	lb   kg
Battery:	2 x 1.5V AAA batteries
Platform:	Tempered Glass
Auto-off:	20 seconds
LCD Display:	2.9" x 1.1" (74 x 28.5 mm)
Dimensions:	11.8" x 11.8" x 0.8" (300 x 300 x 22 mm)

# Troubleshooting

<b>Error Message</b>	<b>Reason</b>	<b>Solution</b>
"Err"	Maximum weight capacity has been exceeded.	Step off the scale to avoid damage.
	Item being weighed is too light.	Remove item and use a smaller scale to measure object.
"Lo"	Low battery.	Replace the batteries as noted in the Battery Replacement section.
"C"	Scale needs to be calibrated.	Recalibrate the scale.
Scale is not turning on.	Batteries may be incorrectly installed.	Take out batteries and reinstall them under the correct polarity.
	Batteries may need to be replaced.	Replace batteries.
	Light does not come on when stepping on scale.	Scale may be broken. Contact customer support

# Warranty

<b>Product</b>	EB9380H Digital Body Weight Scale
<b>Default Warranty Period</b>	1 year
For your own reference, we strongly recommend that you record your Order Number and date of purchase.	
<b>Order Number:</b>	
<b>Date of Purchase:</b>	

## TERMS & POLICY

Etekcity warrants all products to be of the highest quality in material, craftsmanship, and service. effective starting from the date of purchase.

Etekcity will replace any product found to be defective due to manufacturer flaws based on eligibility; refunds are available within the first 30 days of purchase. This warranty extends only to personal use and does not extend to any product that has been used for commercial, rental, or any other use in which the product is not intended for. There are no warranties other than the warranties expressly set forth with each product.

This warranty is non-transferrable. Etekcity is not responsible in any way for any damages, losses or inconveniences caused by equipment failure or by user negligence, abuse, or use noncompliant with the user manual or any additional safety, use, or warnings included in the product packaging and manual.

### **This warranty does not apply to the following:**

- Damage due to abuse, accident, alteration, misuse, tampering or vandalism.
- Improper or inadequate maintenance.
- Damage in return transit.
- Unsupervised use by children under 18 years of age.

Etekcity and its subsidiaries assume no liability for damage caused by the use of the product other than for its intended use or as instructed in the user manual. Some states do not allow this exclusion or limitation of incidental or consequential losses so the foregoing disclaimer may not apply to you. This warranty gives you specific legal rights and you may also have other rights which may vary from state to state.

### **ALL EXPRESSED AND IMPLIED WARRANTIES, INCLUDING THE WARRANTY OF MERCHANTABILITY, ARE LIMITED TO THE PERIOD OF THE LIMITED WARRANTY.**

#### **Additional 1-Year Warranty**

You can extend your one-year warranty by an additional year. Log onto [www.etekcity.com/warranty](http://www.etekcity.com/warranty) and enter your order number (i.e. Amazon or Houzz) to register your new product for the extended warranty.

If you are unable to provide the order number for your product, or if your product has been gifted to you, please type a short note in the order number field along with the date you received your product (i.e. "Gift received on dd/mm/yy").

**<http://www.etekcity.com/warranty>**

#### **Defective Products & Returns**

Should your product prove defective within the specified warranty period, please contact Customer Support via [support@etekcity.com](mailto:support@etekcity.com) with your order number. Once our customer service team has approved your request, please return the unit with a copy of the invoice or your order number.

# Customer Support

Should you encounter any issues or have any questions regarding your new product, feel free to contact our helpful Customer Support Team. Your satisfaction is ours!

## Customer Support

Etekcite Corporation  
1202 N. Miller St. Suite A  
Anaheim, CA 92806

**Toll-Free:** (855) 686-3835

**Fax:** (657) 202-1693

**Local:** (657) 500-1872

**Email:** [support@etekcity.com](mailto:support@etekcity.com)

## Support Hours

**Monday - Friday:**

9:00 am - 5:00 pm PST

*\*Please have your order ID number ready before contacting customer support.*







Scan here to join the community!  
Visit us at **[www.etekcity.com](http://www.etekcity.com)**