

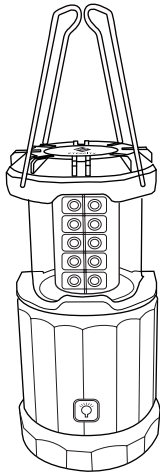

LED Camping Lantern

Model No.: CL30



Thank You.

Thank you for purchasing the CL30 Camping Lantern by Etekcity. We are dedicated to providing our customers with quality products for building a better living. Should you have any questions or concerns about using your new product, feel free to reach out to our helpful customer support team at (855) 686-3835 or by email at support@etekcity.com. We hope you enjoy your new product!

Table of Contents

Safety Information	4
Function Diagram	5
Set Up & Operation	6
Lantern Operation	6
Fire Starter Operation	8
Battery Replacement	8
Specifications	10
Warranty	11
Customer Support	13

Safety Information

WARNING: This product contains materials that, when used together, can ignite flammable substances to use for campfires or emergencies. Always use caution when using these materials, misuse of these materials may result in damage to the product or injury.

IMPORTANT: Please read and comply with all of the instructions and warnings provided in this manual before using the product. Failure to comply with the instructions and warnings provided herein may result in inaccurate results and/or damage to the product itself.

- **DO NOT** use the firestarter in indoor settings (i.e. living rooms, bedrooms, bathrooms, or offices.)
- **DO NOT** use the firestarter near heat sources or flammable objects such as gas canisters, fireworks, or gunpowder. Doing so may cause a fire and result in injury or even possible death.
- **DO NOT** allow children to use or play with the firestarter. The firestarter contains small parts that may present a choking hazard.
- When not in use, turn off the lantern by completely collapsing the device.
- When installing or changing batteries, always make sure to place the batteries under the correct polarity as indicated within the battery compartment.
- **DO NOT** dispose any part of this product in a fire.

- Properly dispose all parts of this product in accordance with local environmental regulations. Do not dispose of the lantern or batteries in regular household waste.
- **DO NOT** submerge or place the lantern in any direct contact to water or any other liquid.
- When cleaning, use a damp or dry cloth to wipe the lantern's surface.
- When not in use for an extended period of time, remove the batteries to avoid power drainage.

Function Diagram

1. Handles
2. LED lights
3. Firestarter compartment
4. Firestarter
5. Starter rod cover
6. Striker
7. Fire Starter rod
8. Dimming button
9. Battery compartment
10. Magnetic base pads.

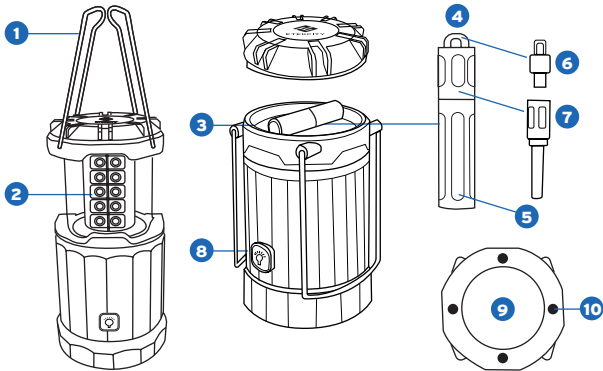

Set-Up & Operation

Lantern Operation

1. Before first use, remove the battery compartment lid by holding the lantern upside down and twisting the base counterclockwise. Remove the insulation strip and replace the battery compartment lid.

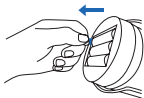

2. Flip out the foldaway handles and pull them up to turn on the lantern.
3. Adjust the height to control the brightness of the emitted light.



4. Press the button on the lantern to adjust the brightness levels. The chart on page 7 describes each brightness setting.



5. Fully collapse the lantern to turn off the light. Fold down the handles and secure them to bottom of the base to ensure the lantern is off.

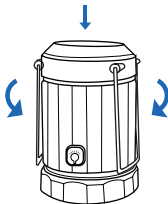

Function	Operation
Turning the lantern on	Pull up the lantern
Press dimming button once	Dims lantern to brightness level 2
Press dimming button twice	Dims lantern to brightness level 3
Press dimming button three times	Dims lantern to brightness level 4
Press dimming button four times	Returns lantern to brightness level 1

NOTE

- Brightness level 1 is the maximum brightness setting.
- The lantern can be attached to metallic surfaces for hands-free lighting.

Fire Starter Operation

1. Remove the top cover on the lantern by twisting it counterclockwise to reveal the fire starter compartment. Take out the fire starter.
2. Twist the starter rod clockwise to remove it from the cover.
3. Remove the striker from the starter rod, and attach it to the starter rod cover.

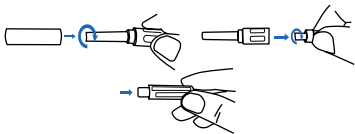

4. Hold the fire starter rod and striker near a dry flammable substance.
5. Strike the fire starter rod with the striker so that sparks are produced. Keep striking the rod until the sparks make contact and ignite the flammable substance.

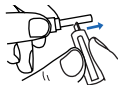

6. Reassemble the fire starter when you are finished. Place the assembly back into the fire starter compartment.

Battery Replacement

1. Remove the battery compartment lid by holding the lantern upside down and twisting the base counterclockwise. Take out the used batteries and dispose of them properly.



2. Install three new AA 1.5V batteries into the lantern, making sure each battery is placed under the correct polarity.

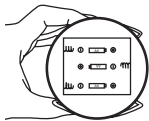

3. Replace the battery compartment lid.

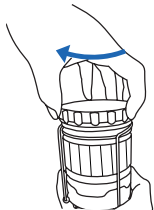

Specifications

Voltage	DC 4.5V (3 x AA 1.5V batteries)
Rated Power	3W
Weight	12.35 oz (350 g)
Waterproof Grade	IP54
Max Lumen	60 Lumen
Fire Starter Rod	Magnesium

Warranty

Terms & Policy

Etekcitec warrants all products to be of the highest quality in material, craftsmanship and service for a minimum of 1 year, effective from the date of purchase. Warranty lengths may vary between product categories. Etekcitec will replace any product found to be defective due to manufacturer flaws based on eligibility; refunds are available within the first 30 days of purchase. This warranty extends only to personal use and does not extend to any product that has been used for commercial, rental, or any other use in which the product is not intended for. There are no warranties other than the warranties expressly set forth with each product.

This warranty is non-transferrable. Etekcitec is not responsible in any way for any damages, losses or inconveniences caused by equipment failure or by user negligence, abuse, or use noncompliant with

the user manual or any additional safety, use, or warnings included in the product packaging and manual.

This warranty does not apply to the following:

- Damage due to abuse, accident, alteration, misuse, tampering or vandalism.
- Improper or inadequate maintenance.
- Damage in return transit.
- Unsupervised use by children under 18 years of age.

Etekcitec and its subsidiaries assume no liability for damage caused by the use of the product other than for its intended use or as instructed in the user manual. Some states do not allow this exclusion or limitation of incidental or consequential losses so the foregoing disclaimer may not apply to you. This warranty gives you specific legal rights and you may also have other rights which may vary from state to state.

ALL EXPRESSED AND IMPLIED WARRANTIES, INCLUDING THE WARRANTY OF MERCHANTABILITY, ARE LIMITED TO THE PERIOD OF THE LIMITED WARRANTY.

Should your product prove defective within the specified warranty period, please return the defective unit in its original packaging with (1) an original copy of the invoice, (2) your order confirmation number, (3) and your warranty ID number.

To find out more about extending your warranty, visit www.etekcity.com/warranty or contact customer support.

Date of Purchase	
Place of Purchase	
Order Number	

Customer Support

Should you encounter any issues or have any questions regarding your new product, feel free to contact our helpful Customer Support Team. Your satisfaction is our goal!

Customer Support

Etekcite Corporation
1202 N. Miller St. Suite A
Anaheim, CA 92806

Local: (657)500-1872
Toll Free: (855)686-3835
Fax: (657)202-1693
Email: support@etekcity.com

Support Hours

Monday - Friday:
9:00 am - 5:00 pm PST

**Please have your order confirmation number ready before contacting customer support.*



Scan here to join the community!
Visit us at **www.etekcity.com**

